

fischer[®]technik

Ergänzung zu den Grundkästen

Statik 3

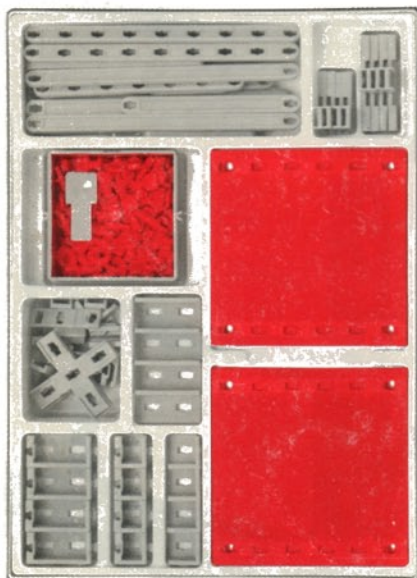

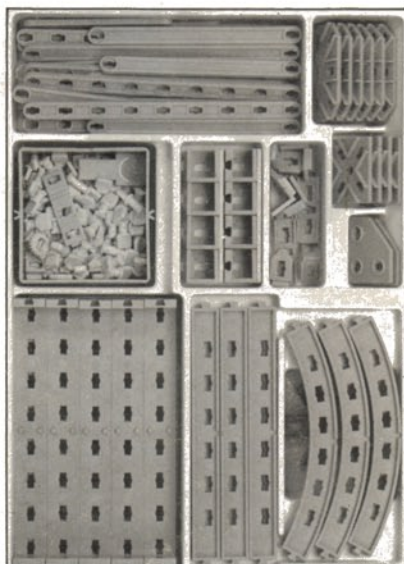
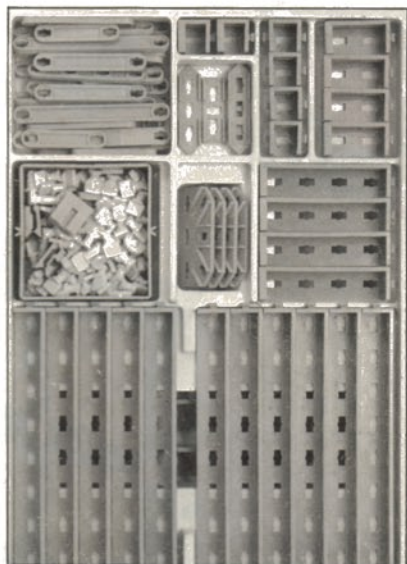
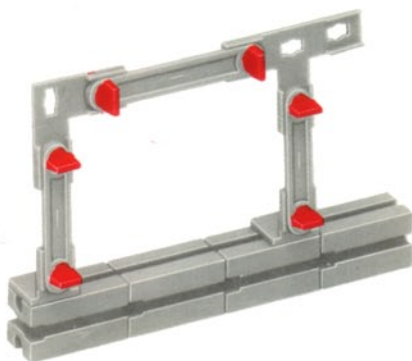
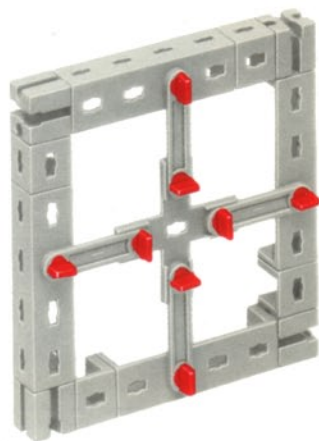
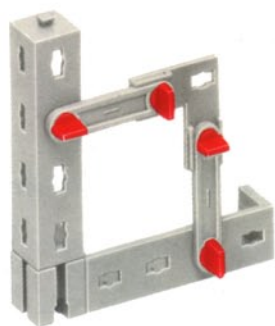

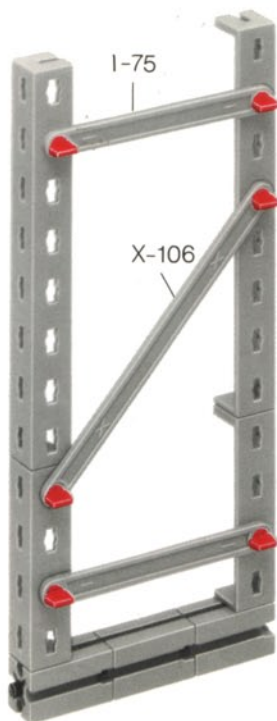
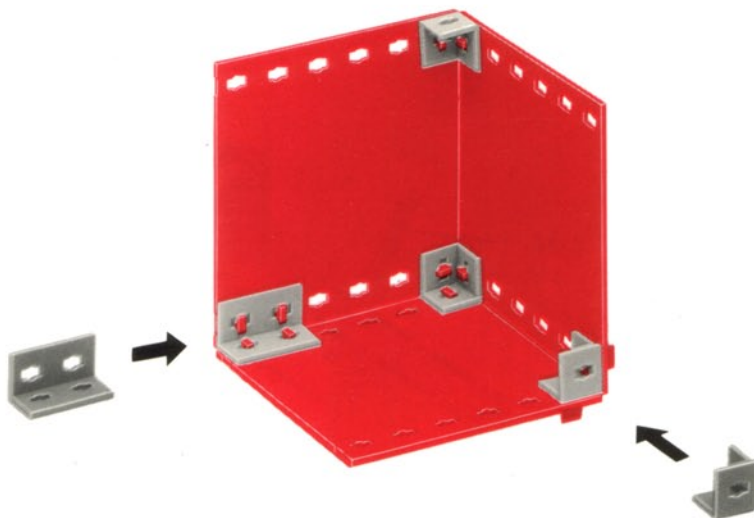

Statik 3 + 50

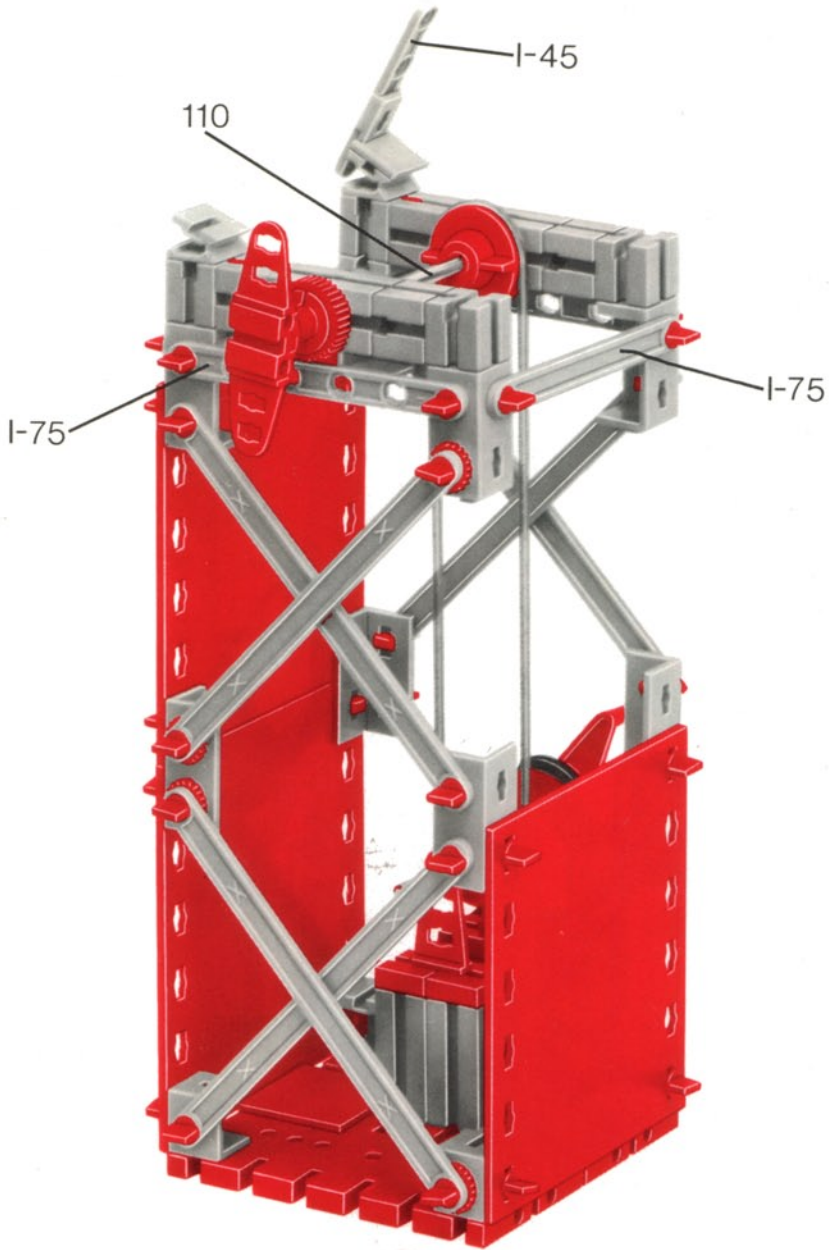

Statik 3 + 50

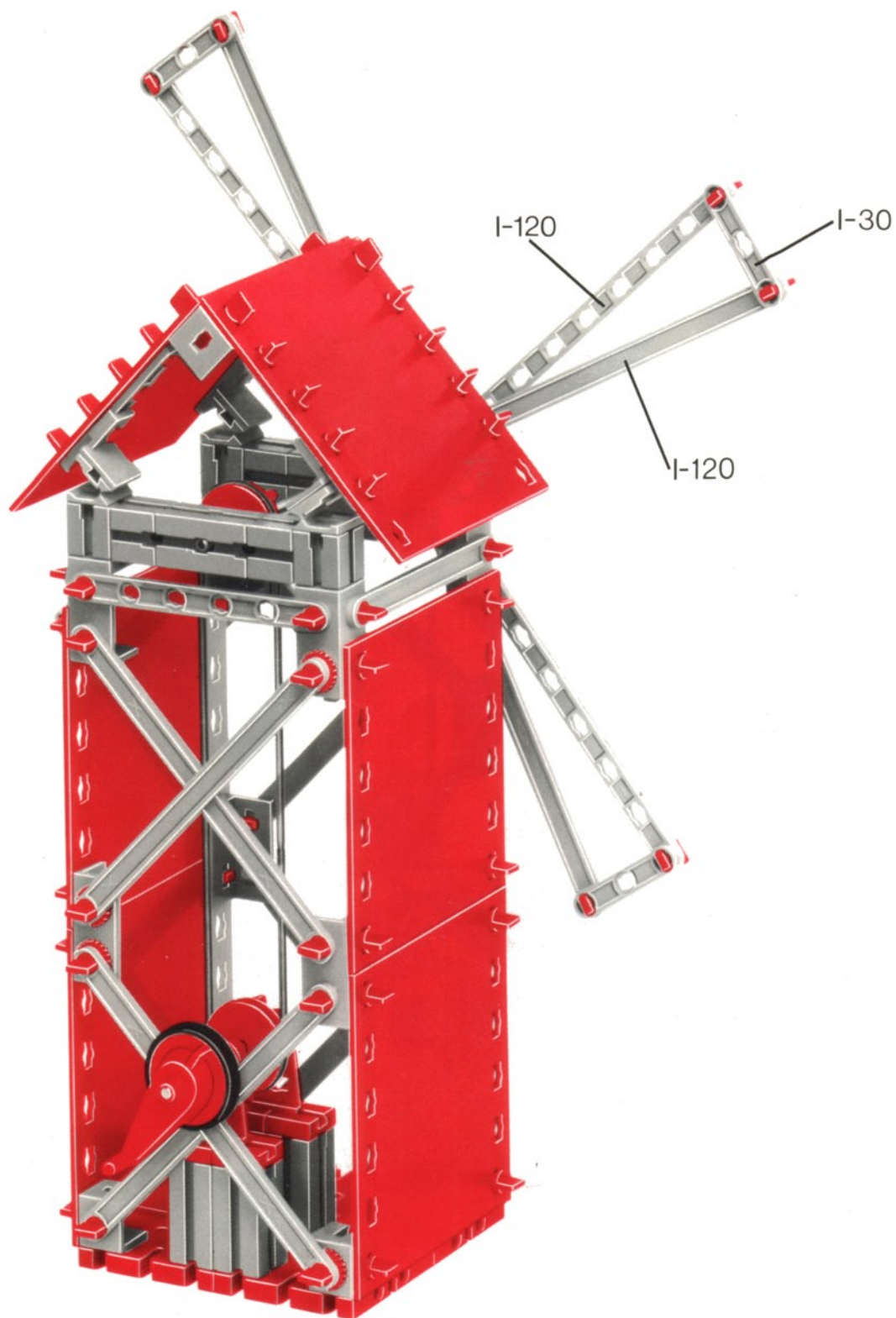



Statik 1 + Statik 2 + Statik 3 + 50

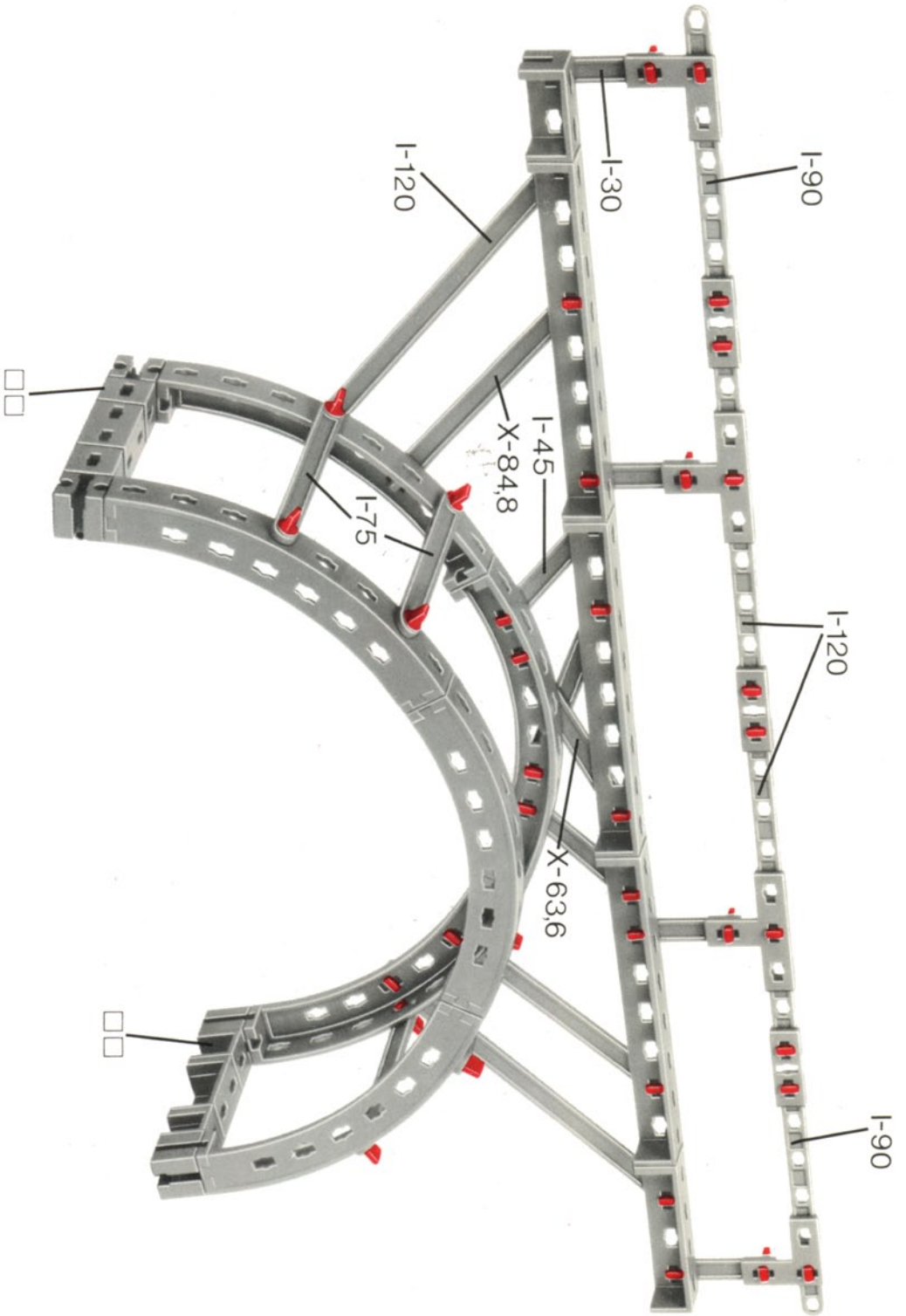

Statik 1 + Statik 2 + Statik 3 + 50

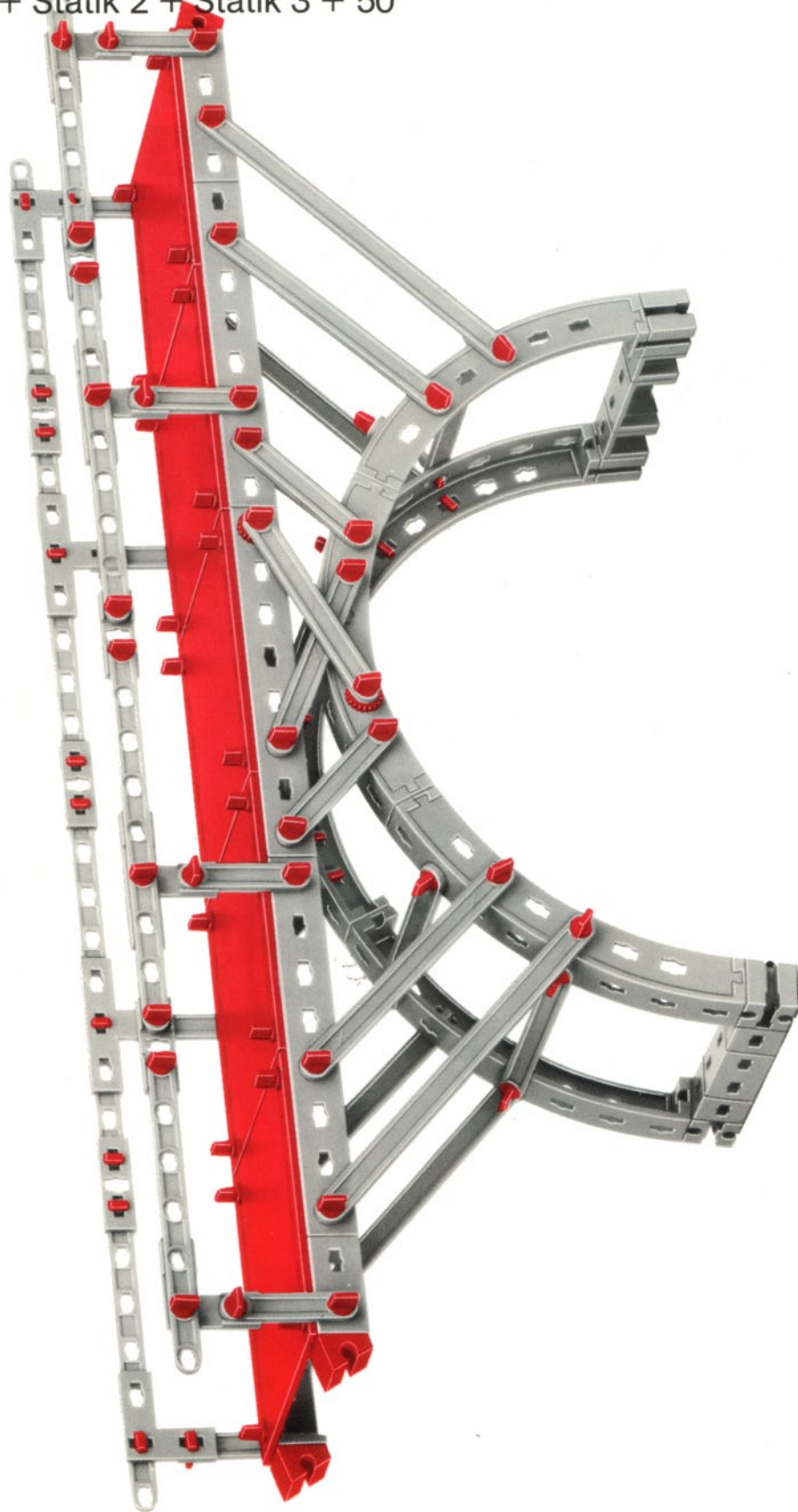

Statik 1 + Statik 2 + Statik 3 + 100

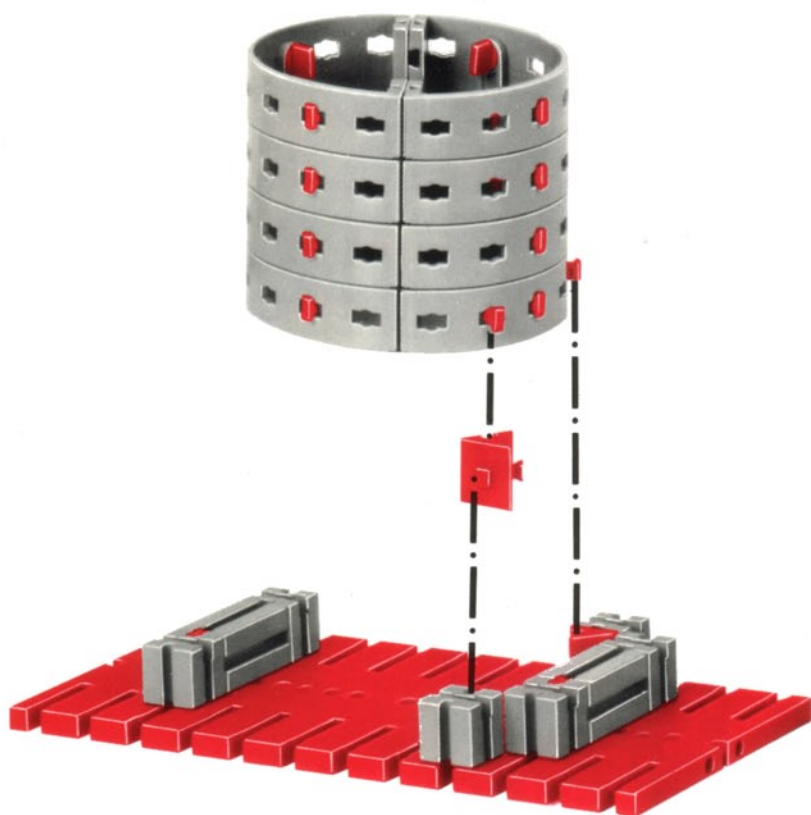

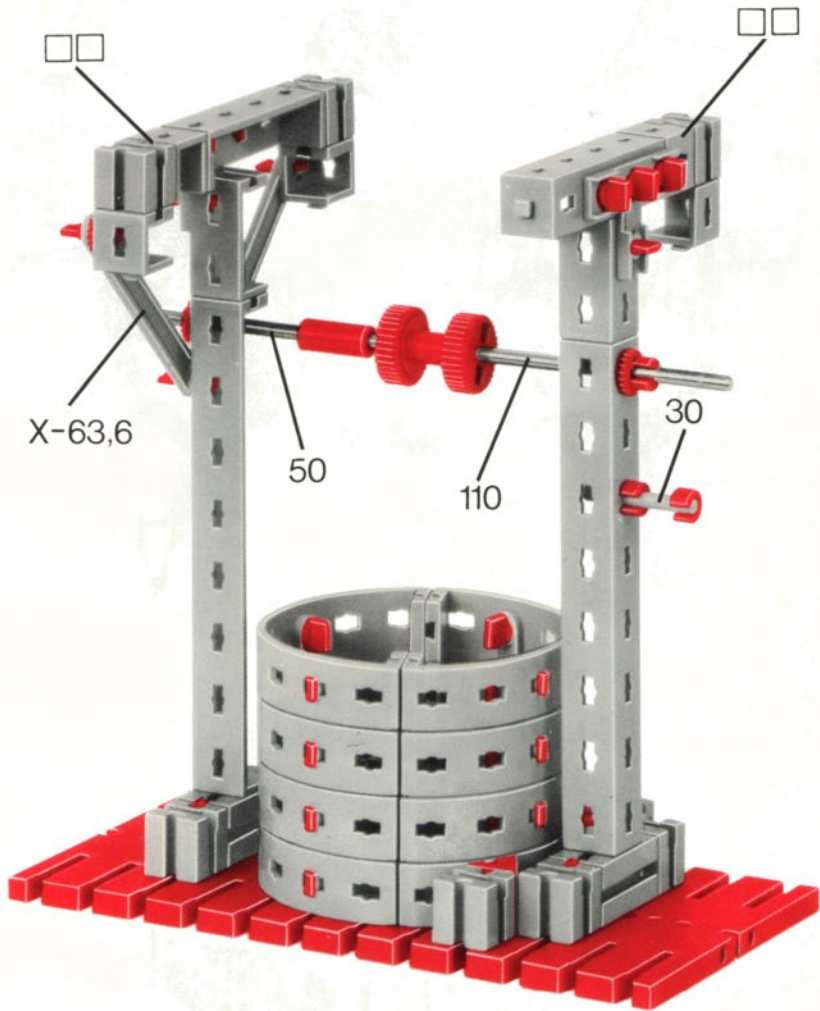

Statik 1 + Statik 2 + Statik 3 + 100

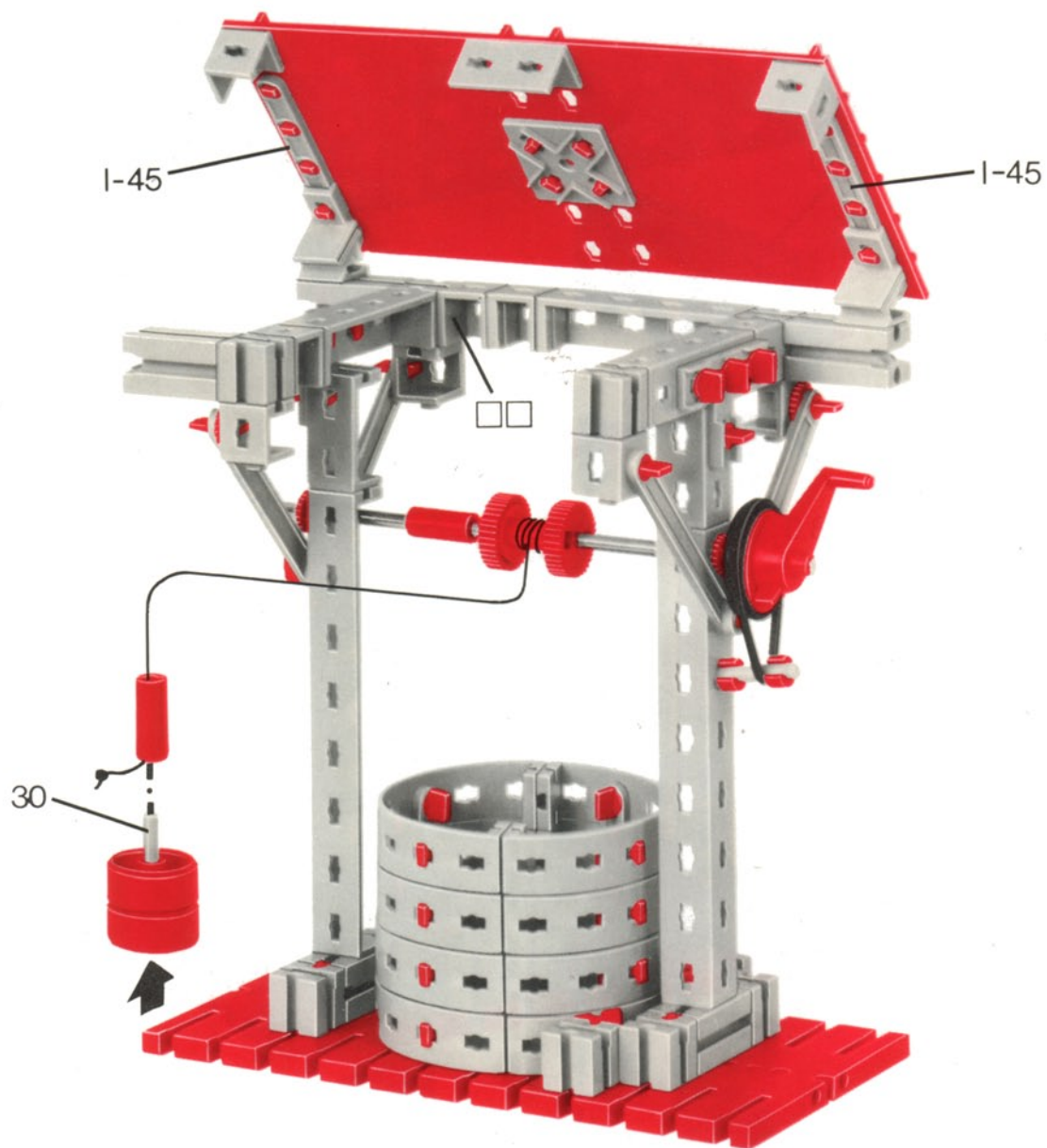

Statik 1 + Statik 2 + Statik 3 + 100



Statik 1 + Statik 2 + Statik 3 + 100

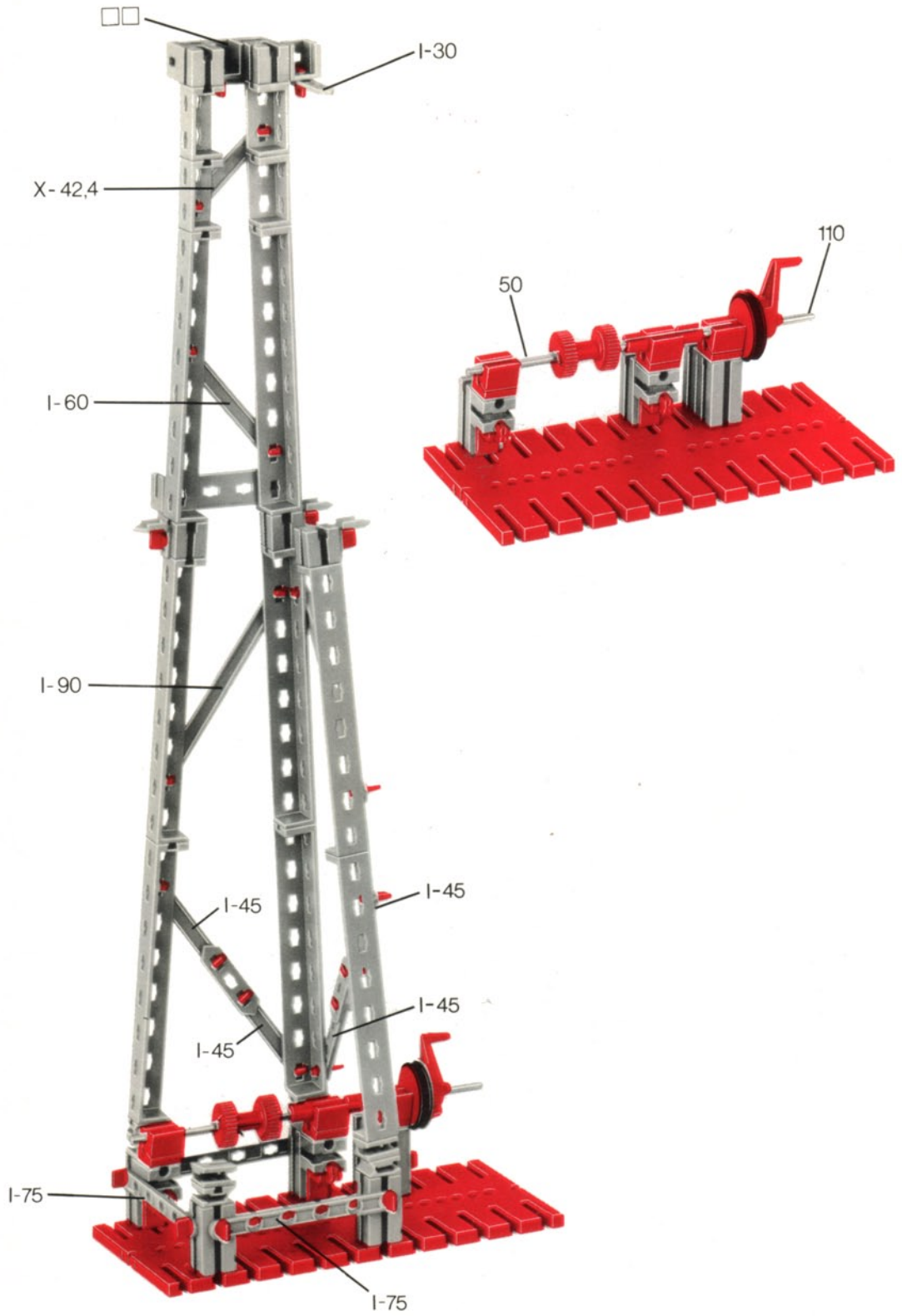

Statik 1 + Statik 2 + Statik 3 + 100

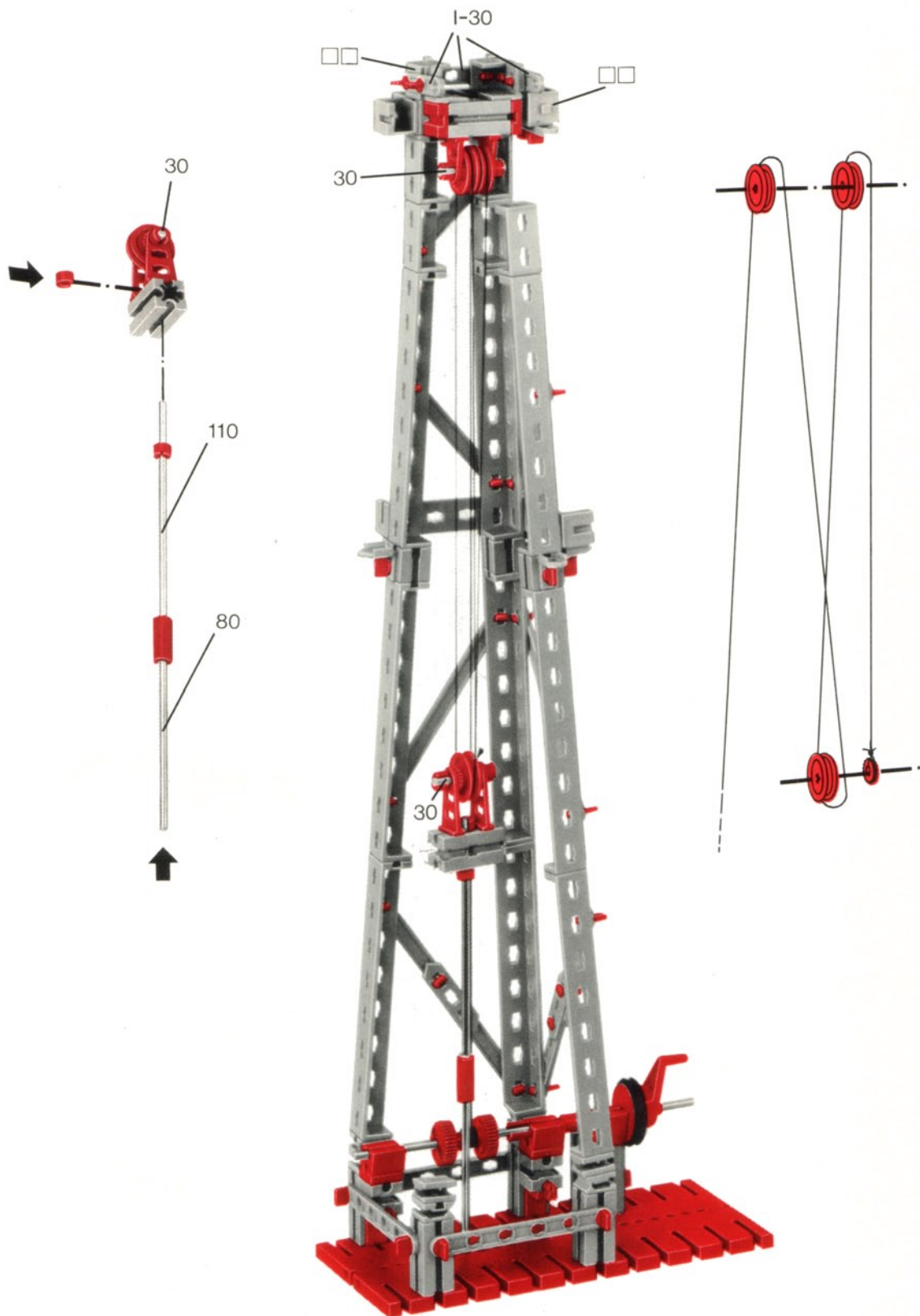

Statik 1 + Statik 2 + Statik 3 + 100



Statik 1 + Statik 2 + Statik 3 + 100

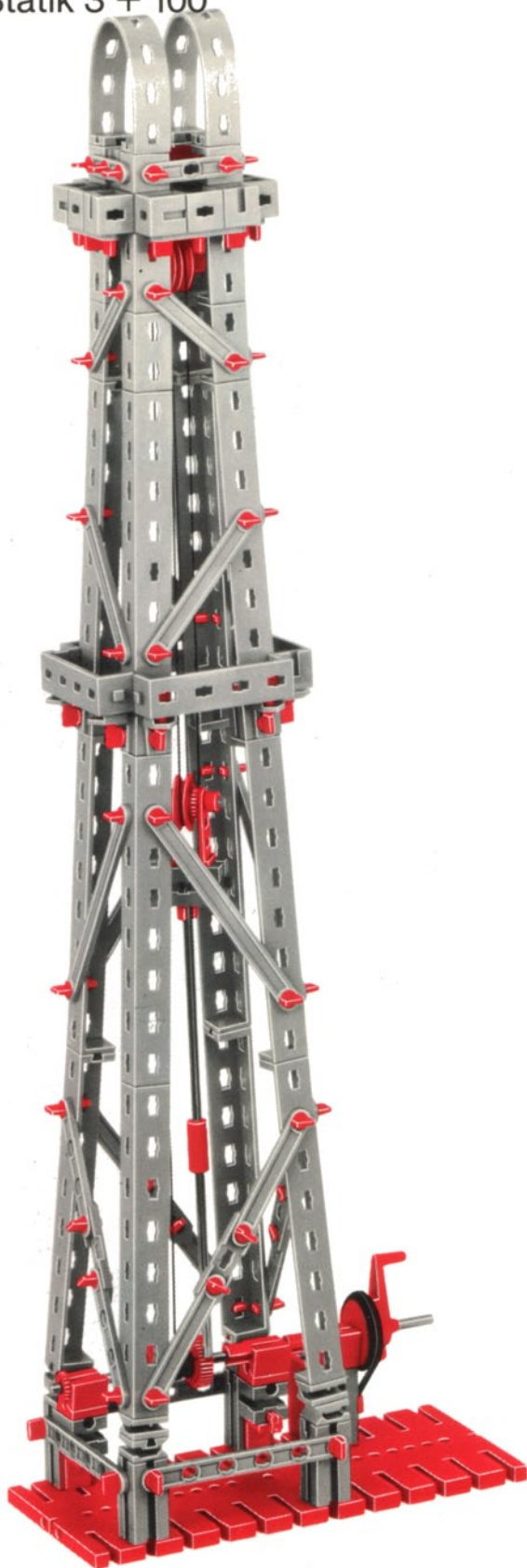

Statik 1 + Statik 2 + Statik 3 + 200

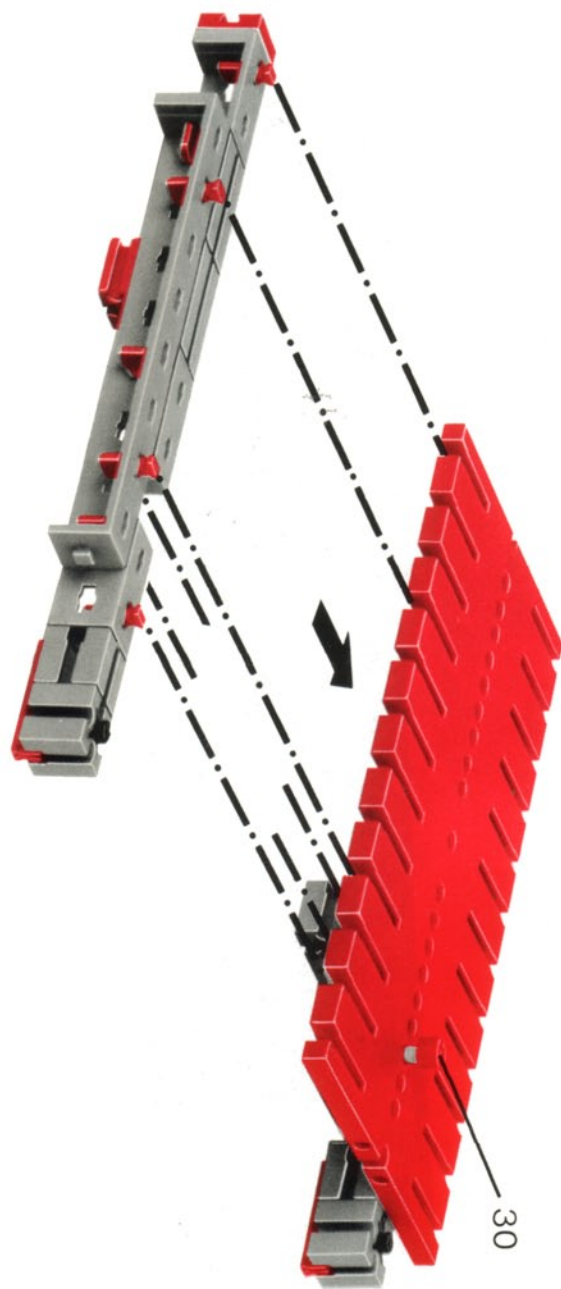

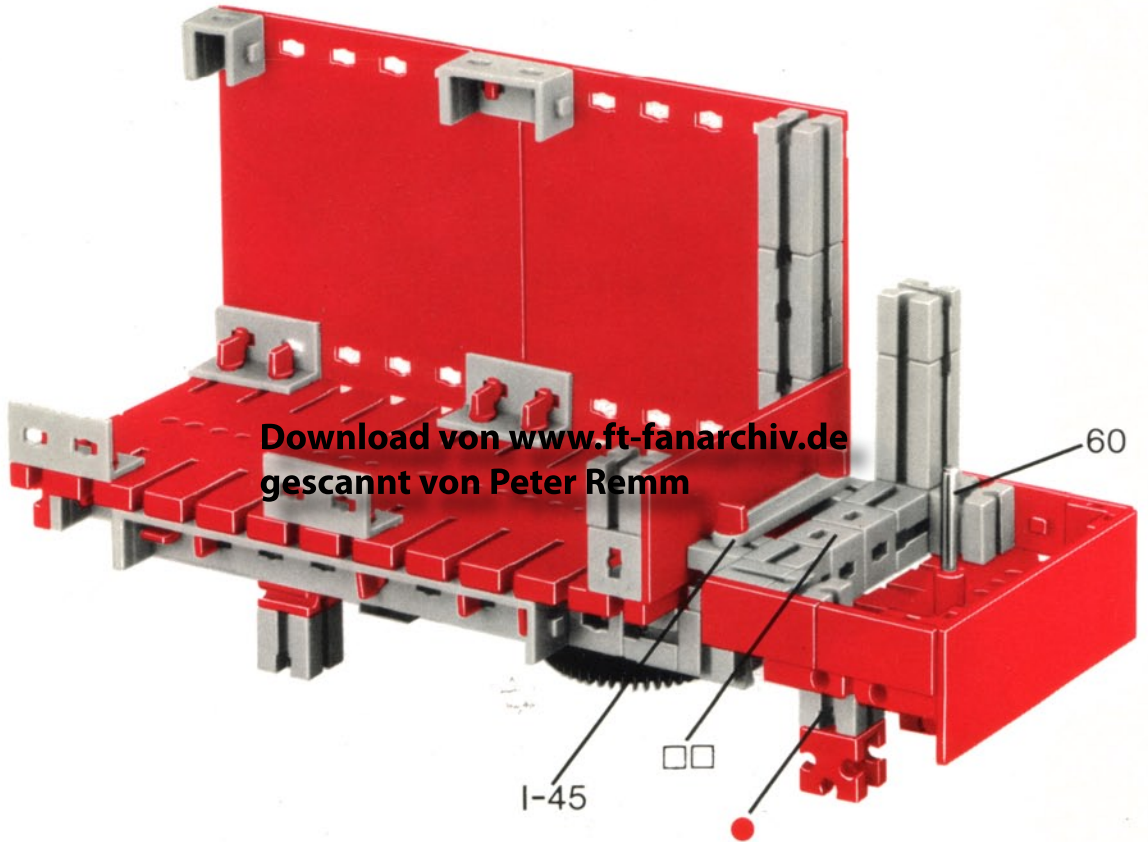

Statik 1 + Statik 2 + Statik 3 + 200

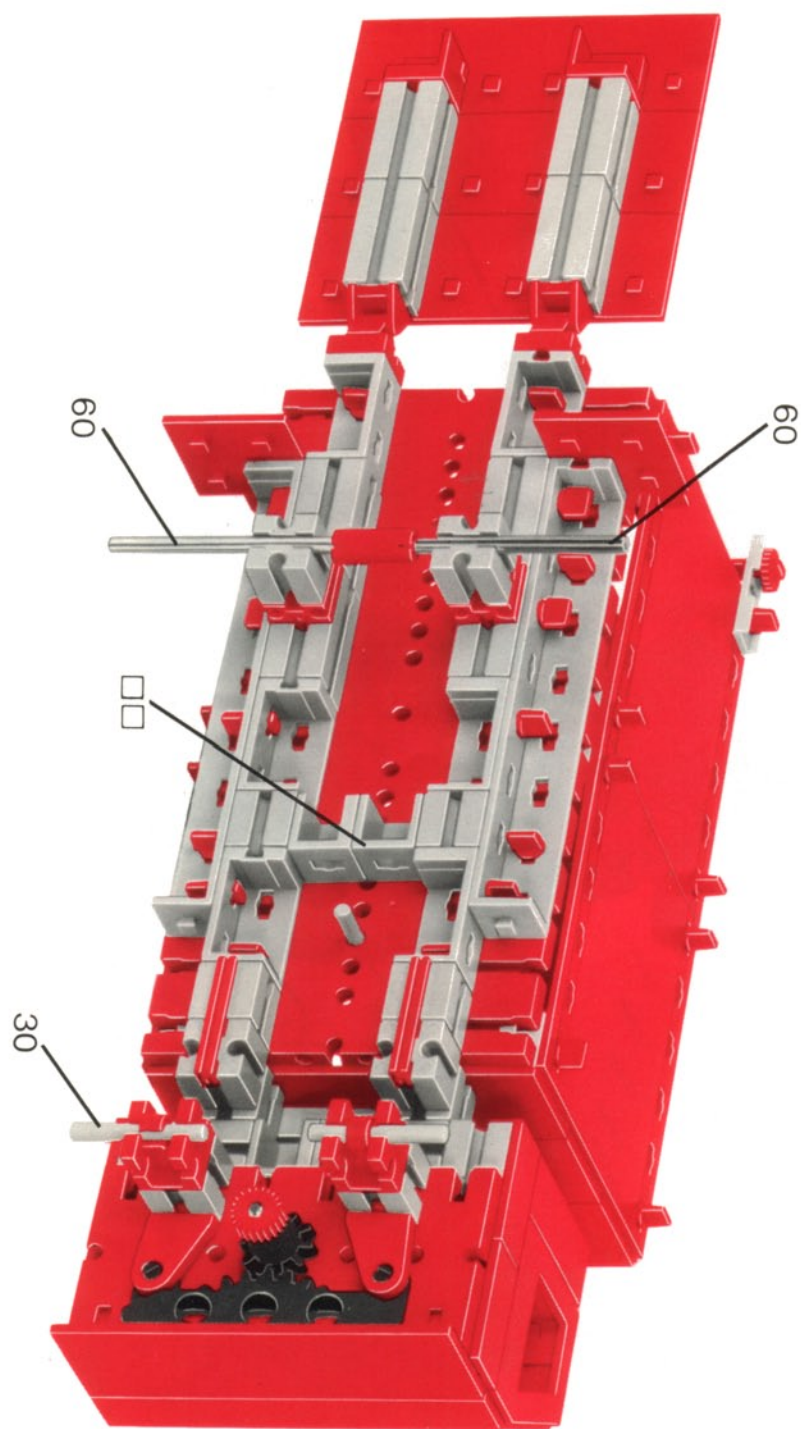

Statik 1 + Statik 2 + Statik 3 + 200

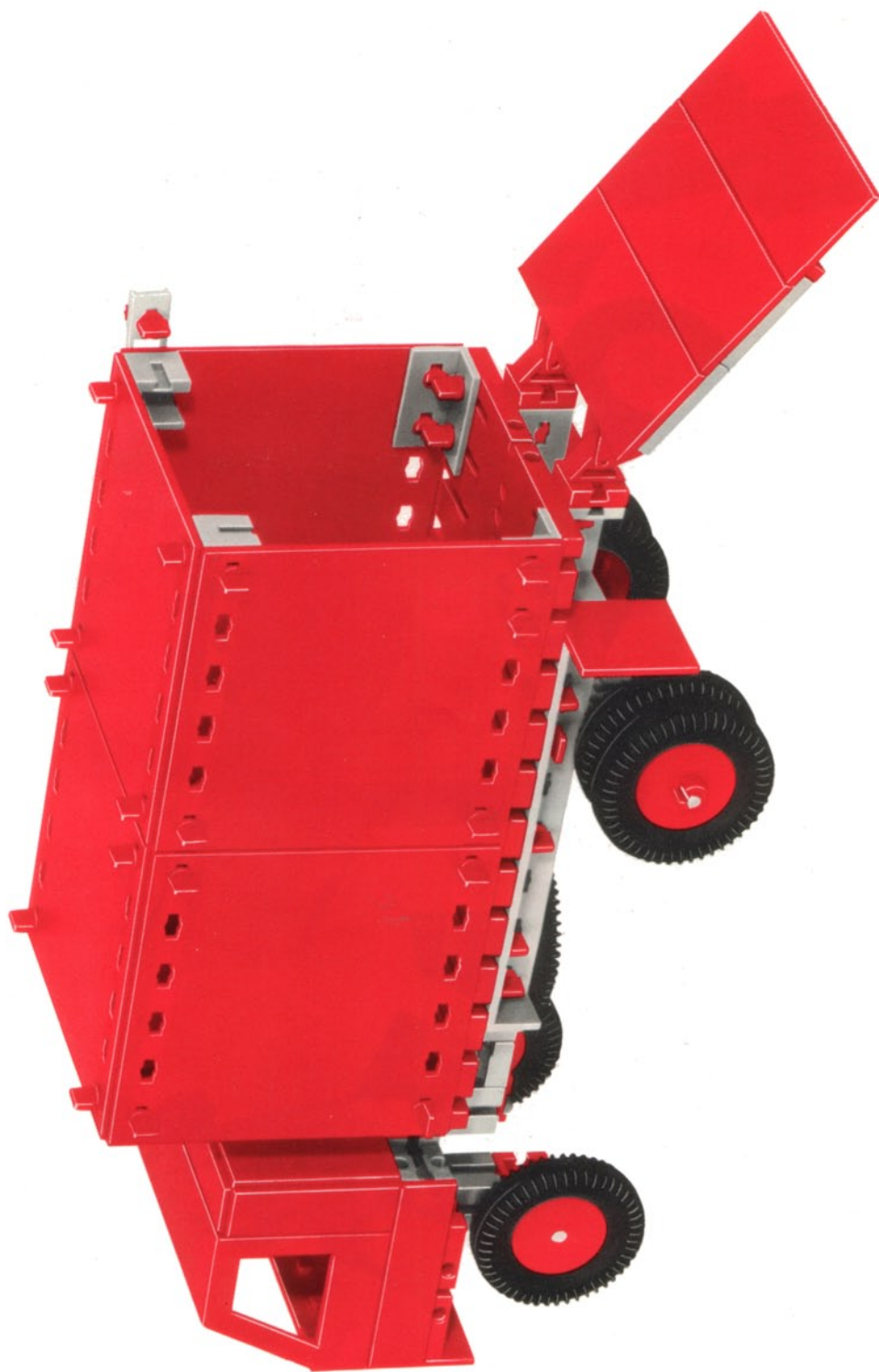

Statik 1 + Statik 2 + Statik 3 + 200

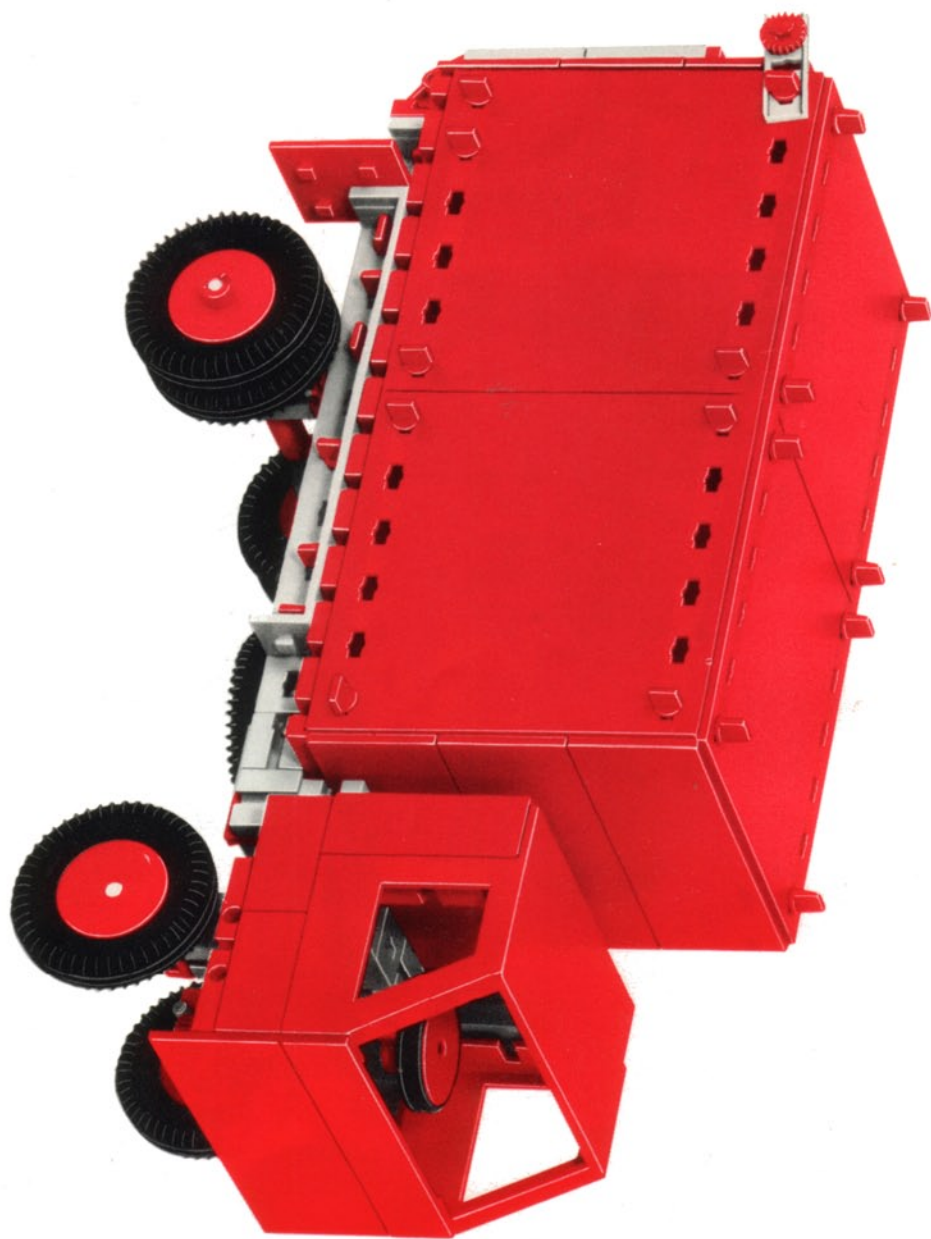

Statik 1 + Statik 2 + Statik 3 + 200

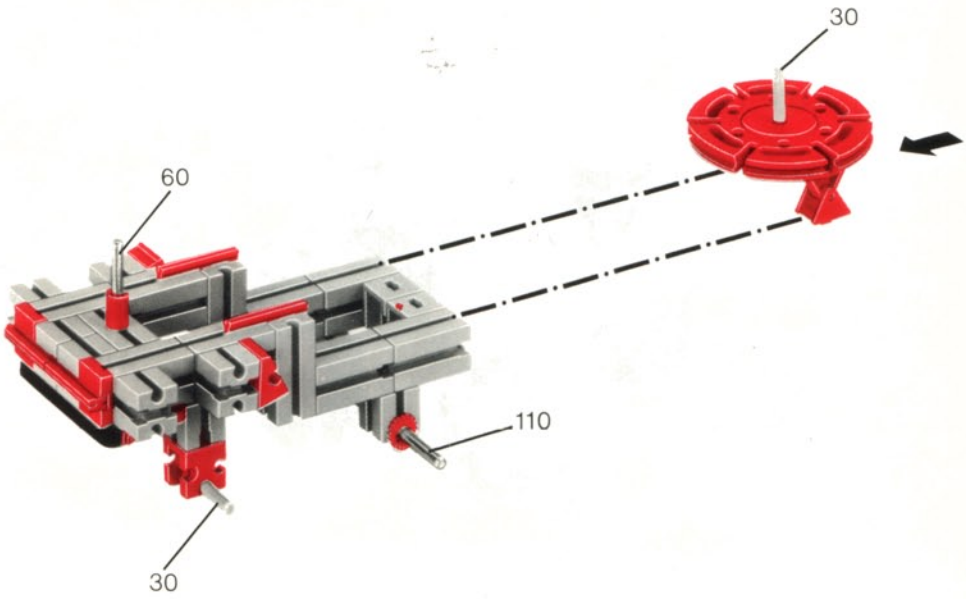
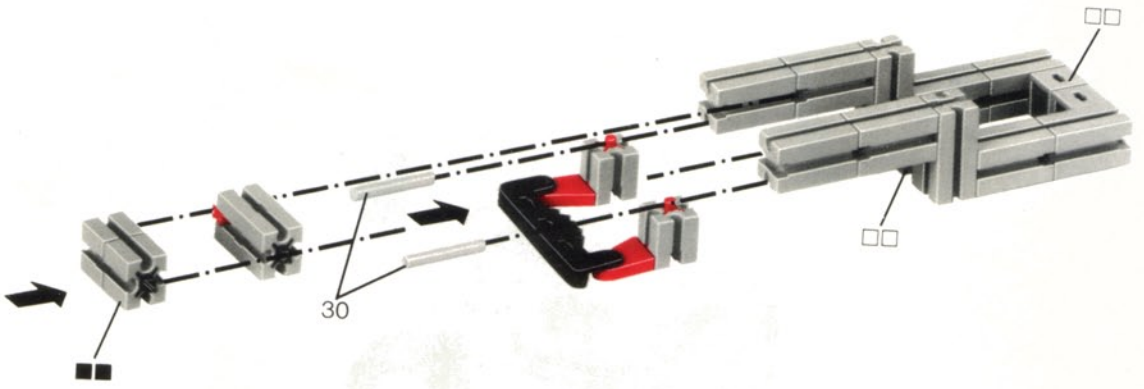

Statik 1 + Statik 2 + Statik 3 + 200

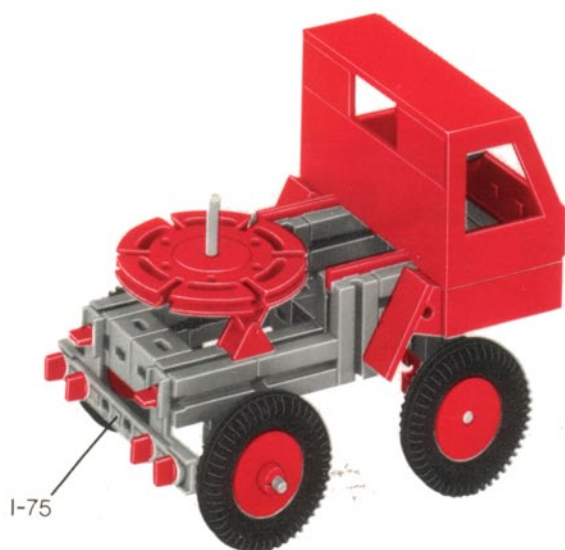

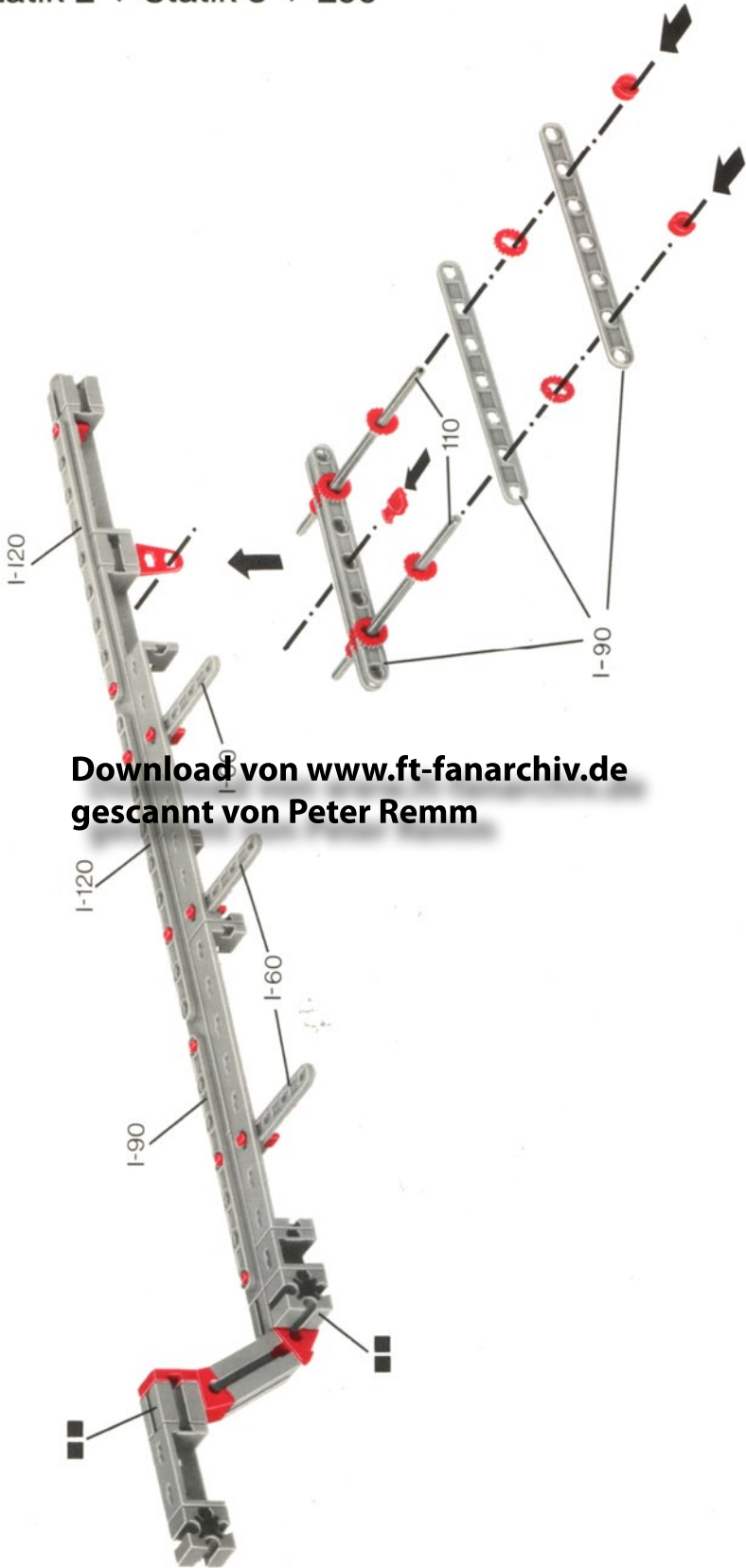

Download von www.ft-fanarchiv.de
gescannt von Peter Remm

Statik 1 + Statik 2 + Statik 3 + 200

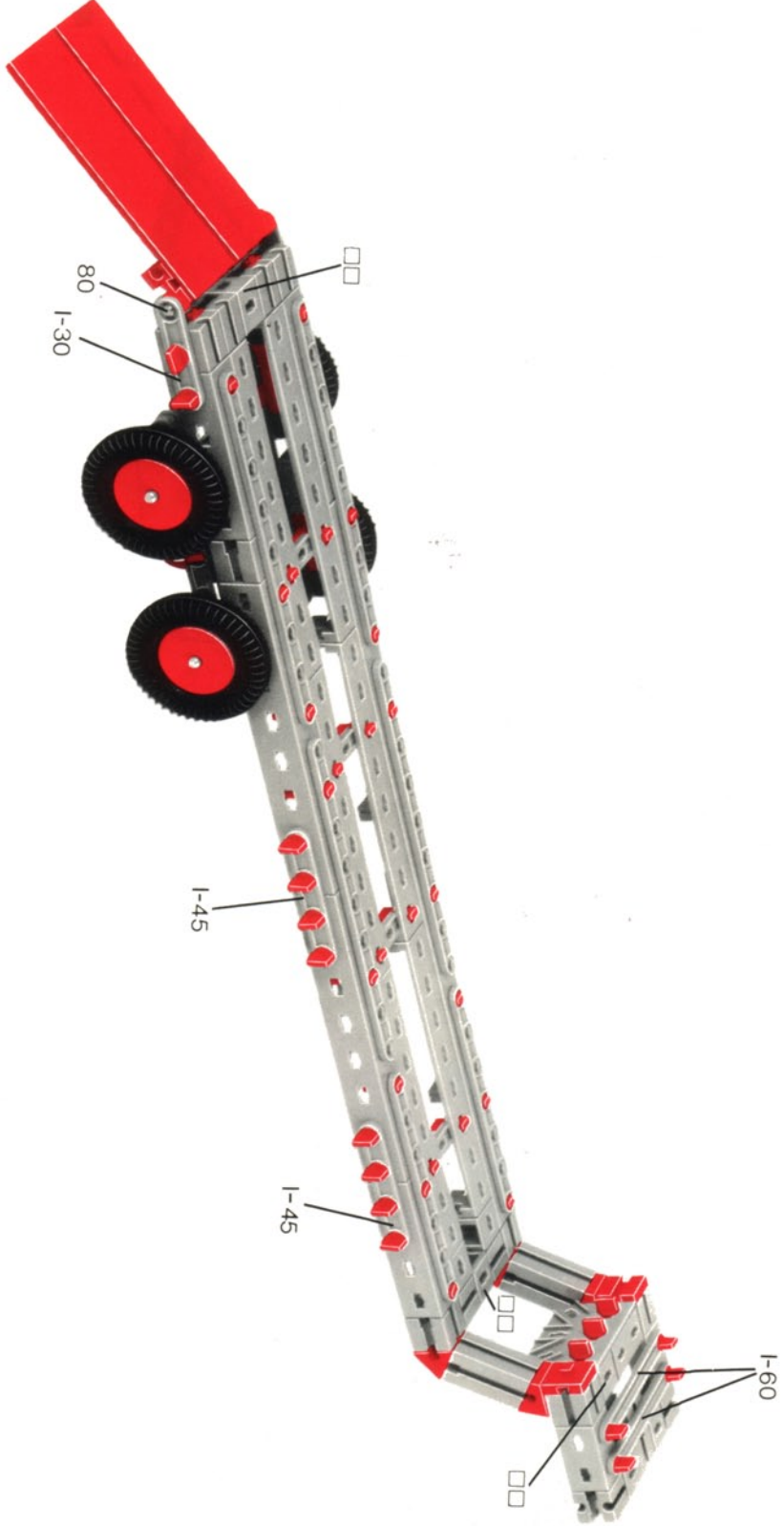

Statik 1 + Statik 2 + Statik 3 + 200



Statik 1 + Statik 2 + Statik 3 + 300

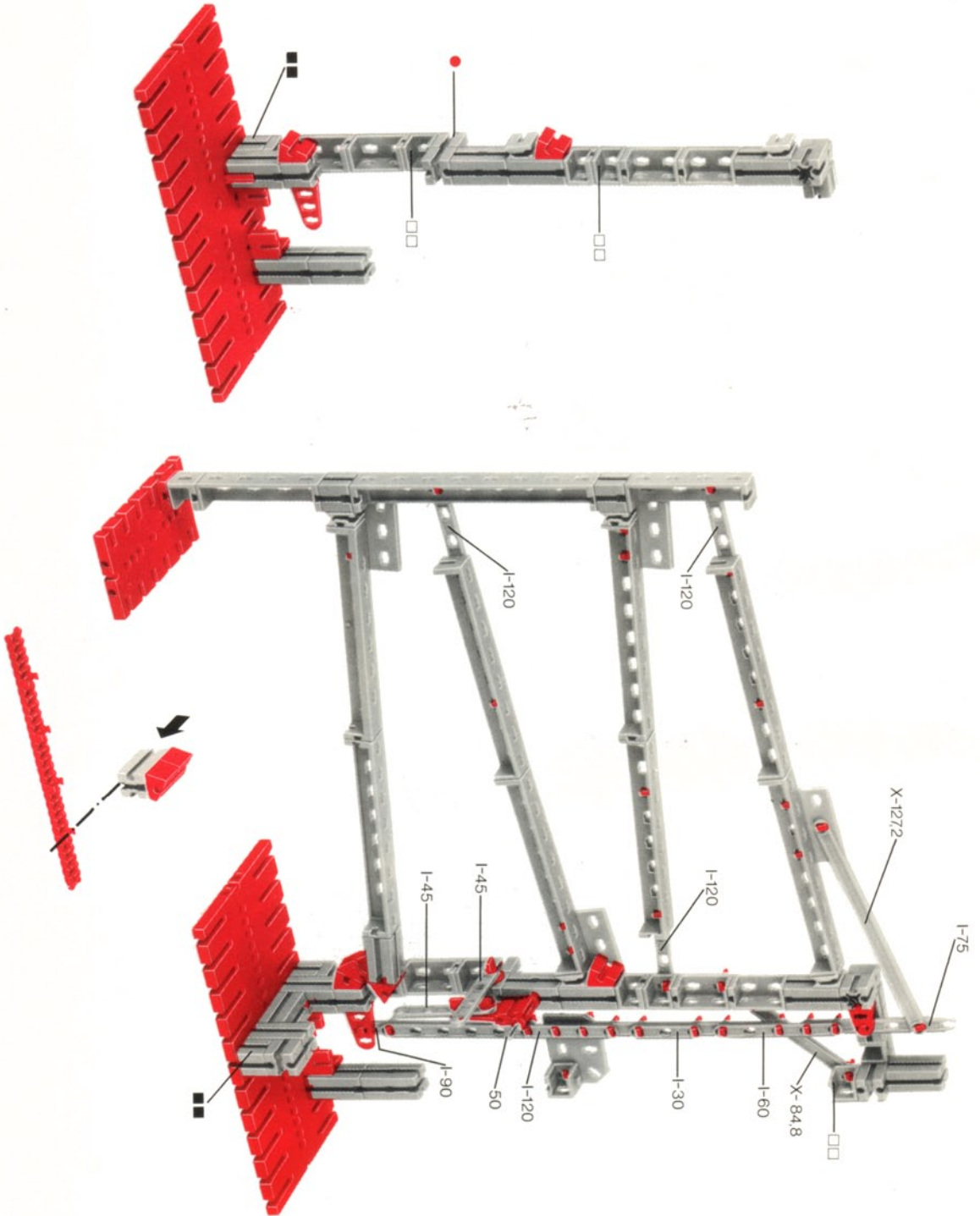

Statik 1 + Statik 2 + Statik 3 + 300

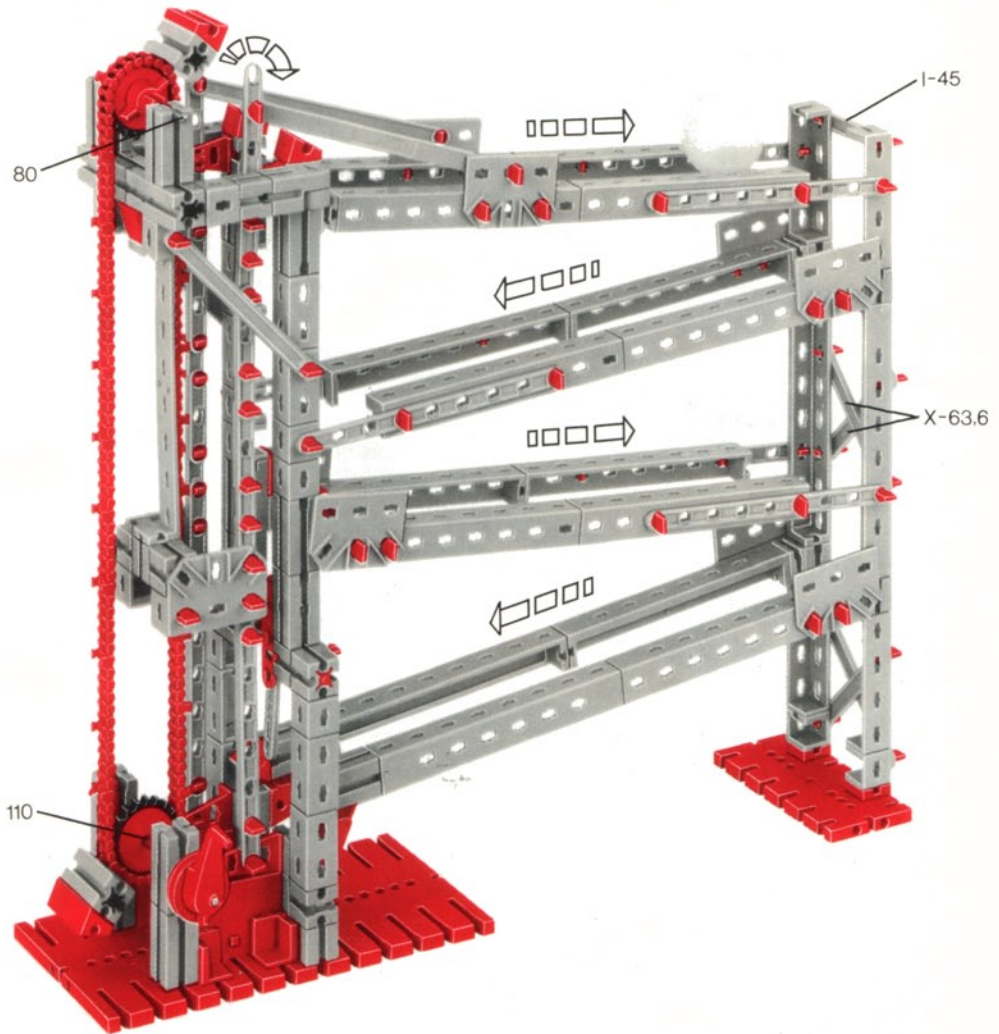

Statik 1 + Statik 2 + Statik 3 + 300

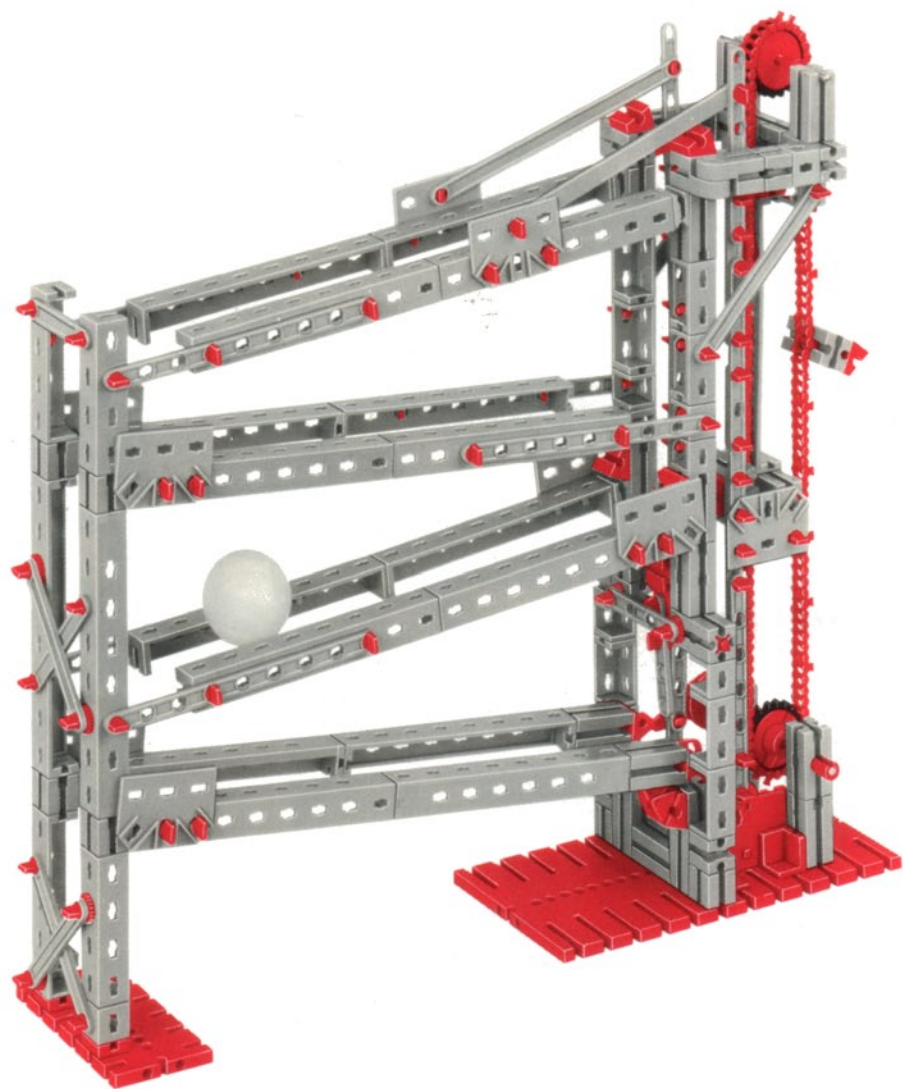

Statik 1 + Statik 2 + Statik 3 + 300

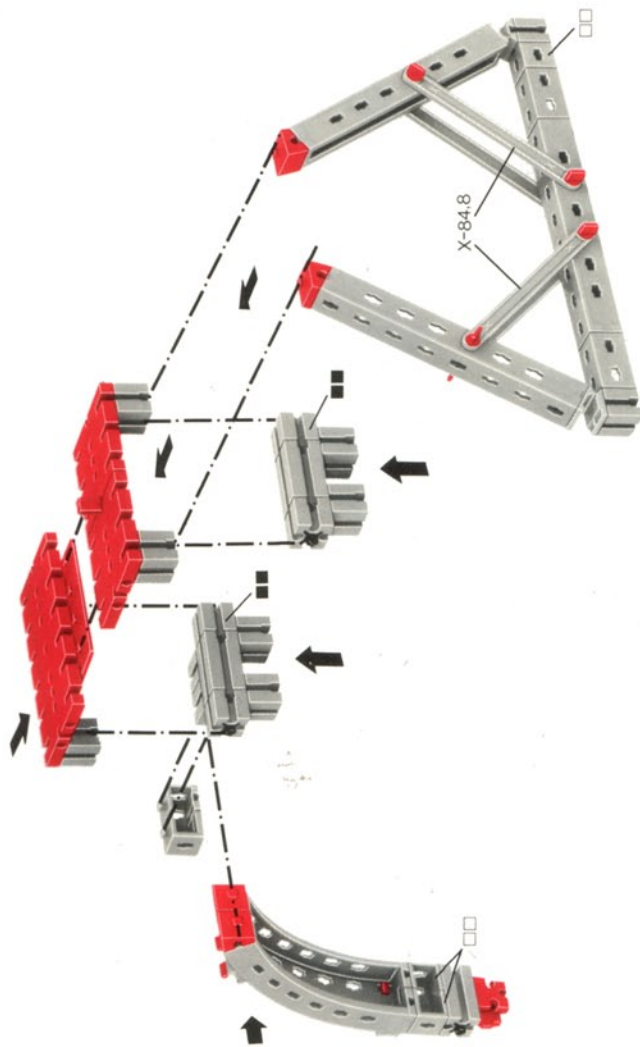

Statik 1 + Statik 2 + Statik 3 + 300

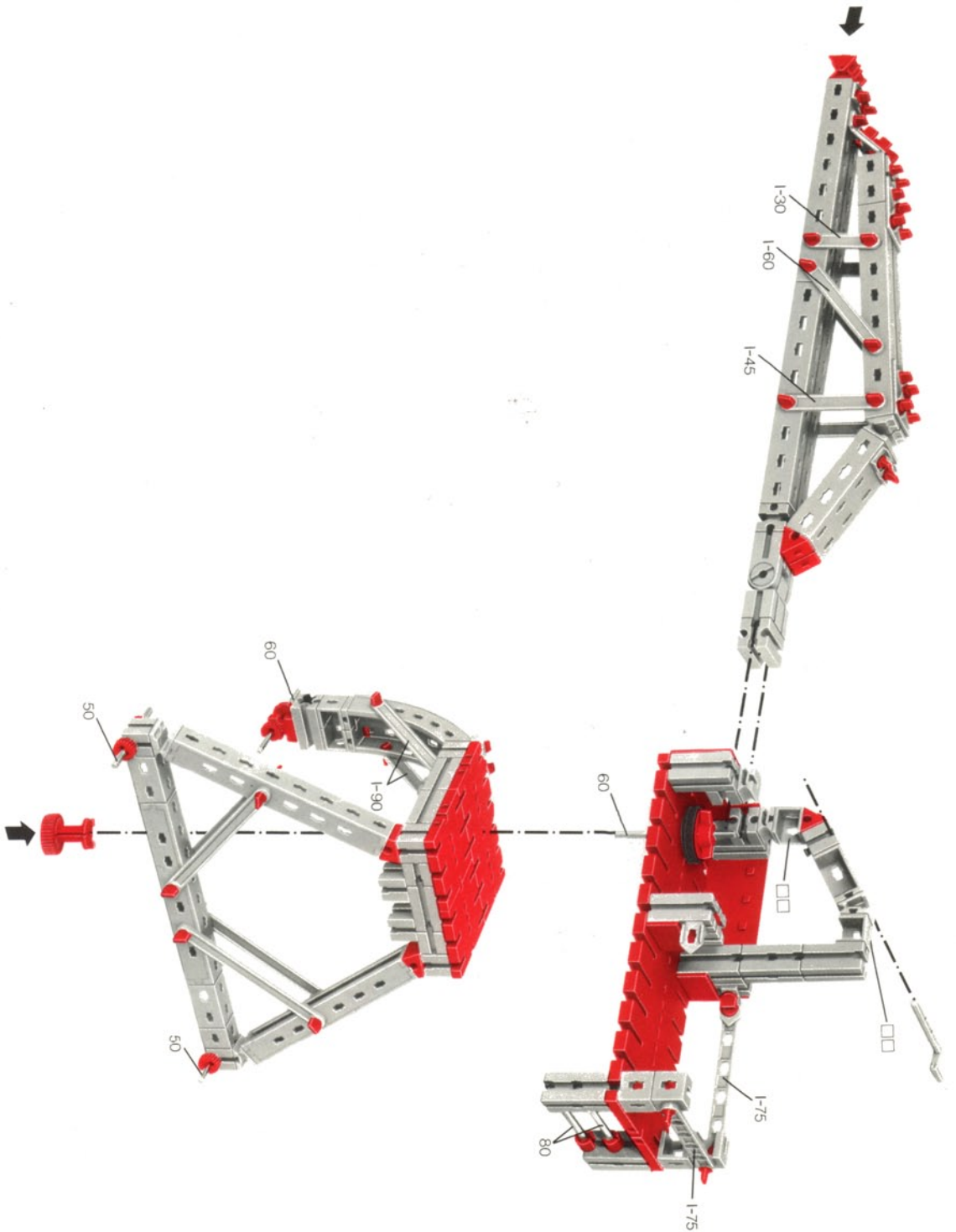



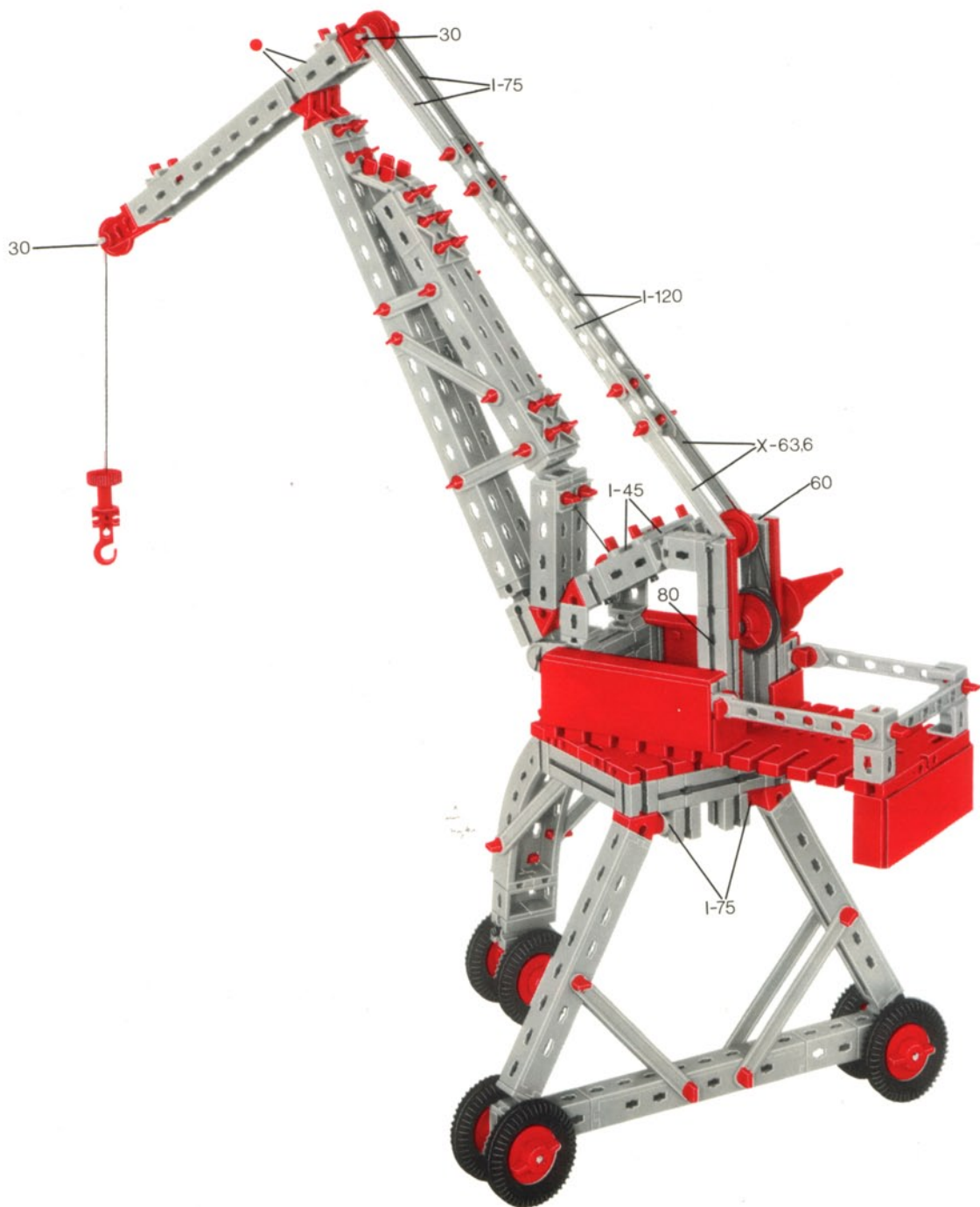

























Statik 1 + Statik 2 + Statik 3 + 300



Statik 1 + Statik 2 + Statik 3 + 300



Stückliste · Parts List · Nomenclature · Onderdelenlijst

	6 Platte 90 x 90 · Panel 90 x 90 · Plaque 90 x 90 · Plaat 90 x 90 Art. Nr. 4 35431 1		4 I-Strebe 45 mit Loch · I-strut 45 with holes · Entretoise type I à perf. mult. de 45 · I-spant 45 met gat Art. Nr. 4 38536 1
	4 L-Lasche · L-gusset · Gousset en L · L-verbinding Art. Nr. 4 31572 1		2 I-Strebe 60 mit Loch · I-strut 60 with holes · Entretoise type I à perf. mult. de 60 · I-spant 60 met gat Art. Nr. 4 38535 1
	4 T-Lasche · T-gusset · Gousset en T · T-verbinding Art. Nr. 4 31573 1		4 I-Strebe 75 mit Loch · I-strut 75 with holes · Entretoise type I à perf. mult. de 75 · I-spant 75 met gat Art. Nr. 4 38534 1
	2 Kreuzlasche · Cross gusset · Gousset en croix · Kruisverbinding Art. Nr. 4 31574 1		4 I-Strebe 90 mit Loch · I-strut 90 with holes · Entretoise type I à perf. mult. de 90 · I-spant 90 met gat Art. Nr. 4 38533 1
	4 Adapterlasche · Adapter gusset · Gousset adaptateur · Adapterverbinding Art. Nr. 4 31575 1		4 I-Strebe 120 mit Loch · I-strut 120 with holes · Entretoise type I à perf. mult. de 120 · I-spant 120 met gat Art. Nr. 4 38532 1
	2 Lasche 15 · Connecting strip 15 · Éclisse de 15 · Rechtverbinding 15 Art. Nr. 4 36326 1		4 Winkellasche · Flexible angle strip · Eclisse coudée · Hoekverbinding Art. Nr. 4 35738 1
	4 Winkelverbinder 30 · Angel connector 30 · Cornière de reprise de 30 · Haakse verbinding Art. Nr. 4 31576 1		2 Gelenkklasche · Flexible connecting strip · Eclisse articulée · Scharnierstuk Art. Nr. 4 36330 1
	4 Eckverbinder · Corner connector · Cornière de reprise d'angle · Hoekstuk Art. Nr. 4 31577 1		70 S-Riegel 4 · Single rivet 4 mm · Rivet de 4 mm · S-grendel 4 mm Art. Nr. 4 36323 1
	4 Winkelträger 15 · Angle girder 15 · Cornière de 15 · Hoekdraagsteun 15 Art. Nr. 4 36300 1		15 S-Riegel 6 · Double rivet 6 mm · Rivet de 6 mm · S-grendel 6 mm Art. Nr. 4 36324 1
	4 Winkelträger 30 · Angle girder 30 · Cornière de 30 · Hoekdraagsteun 30 Art. Nr. 4 36301 1		4 S-Riegel 8 · Triple rivet 8 mm · Rivet de 8 mm · S-grendel 8 mm Art. Nr. 4 36457 1
	4 Scharnier · Hinge · Charnière · Scharnier Art. Nr. 4 36329 1		15 Riegelscheibe · Locking washer · Disque d'arrêt · Grendelschijf Art. Nr. 4 36334 1
	4 I-Strebe 75 · I-strut 75 · Entretoise type I de 75 · I-spant 75 Art. Nr. 4 36312 1		1 S-Griff · Rivet holder · Tourne-rivet · S-greep Art. Nr. 4 35800 1
	4 I-Strebe 120 · I-strut 120 · Entretoise type I de 120 · I-spant 120 Art. Nr. 4 36314 1		1 Kassetten-Unterteil · Cassette, bottom · Coffret, partie inférieure · Cassette, onderstuk Art. Nr. 4 35359 1
	8 X-Strebe 106 · X-strut 106 · Entretoise type X de 106 · X-spant 106 Art. Nr. 4 36318 1		1 Kassetten-Deckel · Cassette, top · Coffret, partie supérieure · Cassette, deksel Art. Nr. 4 35360 1
	4 I-Strebe 30 mit Loch · I-strut 30 with holes · Entretoise type I à perf. mult. de 30 · I-spant 30 met gat Art. Nr. 4 38537 1		

